

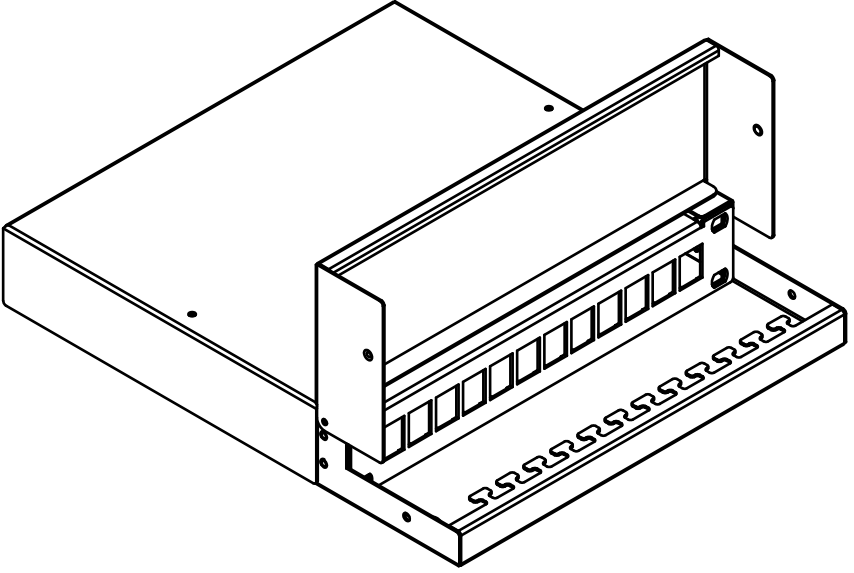

Alle Rechte vorbehalten / all rights reserved. ZVK GmbH, D-94244 Teisnach, Technologiecampus 2, Germany. Phone: +49 9923 804379-0, Fax: +49 9923 804379-50, www.zvk-gmbh.de.

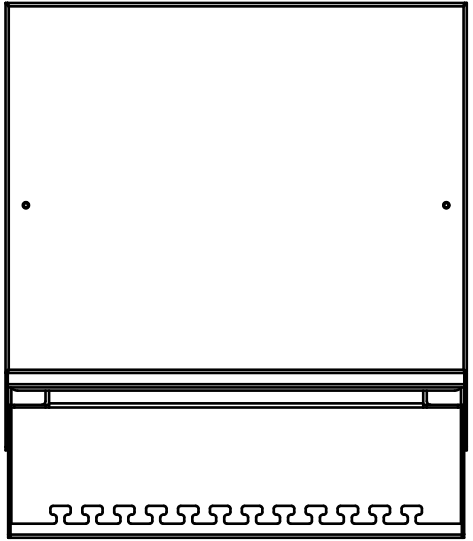
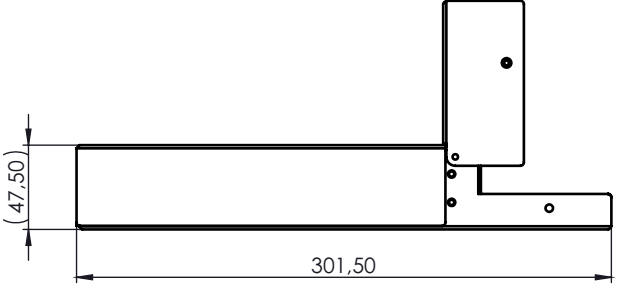
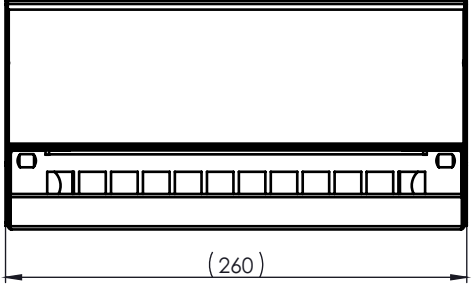

Stahlblech verzinkt, pulverbeschichtet

	gez. / drawn	01.03.2015	Kandler	 EasyLan ...for a better connectivity
	gepr. / appr.			
	Titel / titel: Consolidation Point 10" 1HE für 12 Keystone Module			Maße / Dimensions: mm
	Artikelnummer / article number: ZN-BL151025_A			Original: DIN A4
Änd./ rev. Index	Neuerstellung	01.03.15	Kandler	Blatt / sheet 1 von / of 2

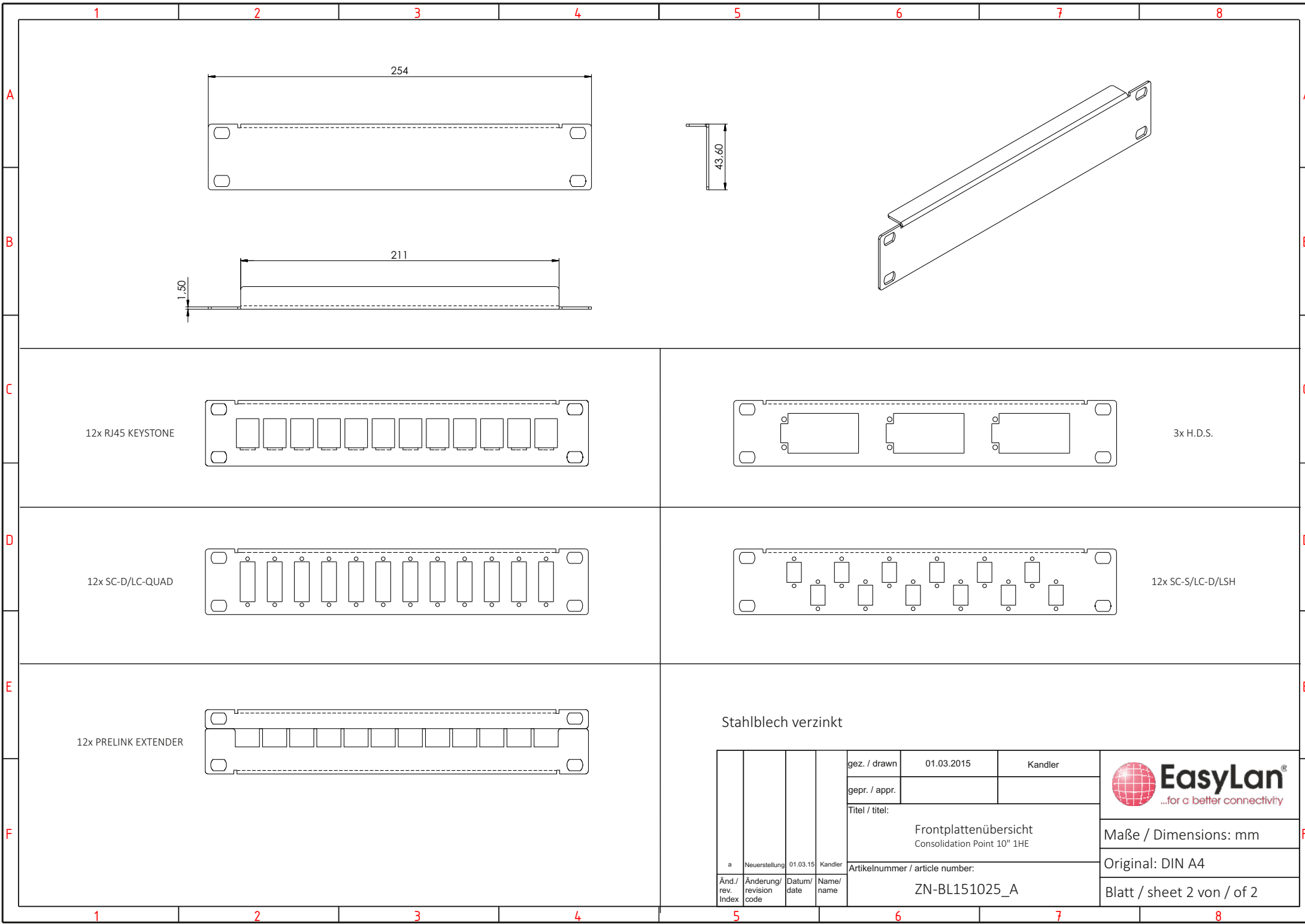

12x RJ45 KEYSTONE

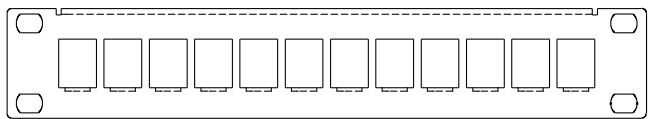

3x H.D.S.

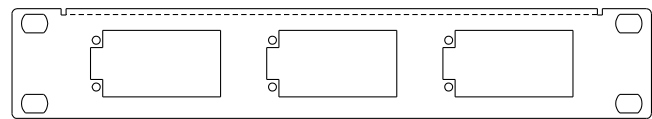

12x SC-D/LC-QUAD

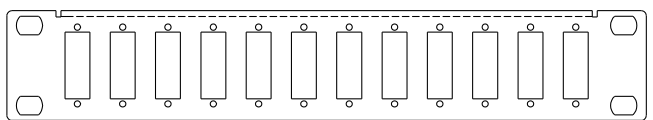

12x SC-S/LC-D/LSH

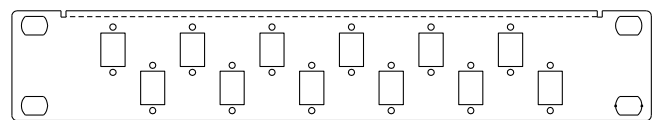

12x PRELINK EXTENDER

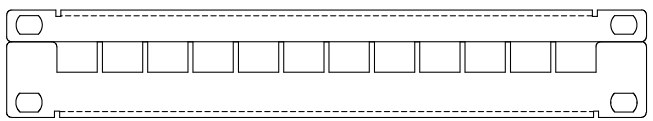

Stahlblech verzinkt

a	Neuerstellung	01.03.15	Kandler	gez. / drawn	01.03.2015	Kandler
	Änd./rev. Index	Änderung/revision code	Datum/date	Name/name		
				Titel / titel:		
				Frontplattenübersicht Consolidation Point 10" 1HE		
				Artikelnummer / article number:		Maße / Dimensions: mm
				ZN-BL151025_A		Original: DIN A4
						Blatt / sheet 2 von / of 2