

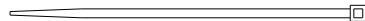

Technisches Datenblatt / technical datasheet

EasyLan® preLink® Steckermodul Kat.6A

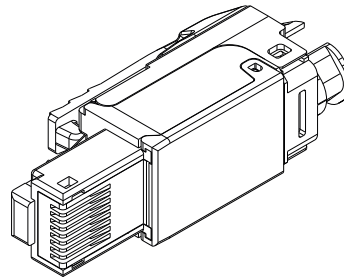
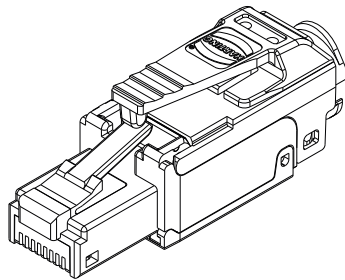
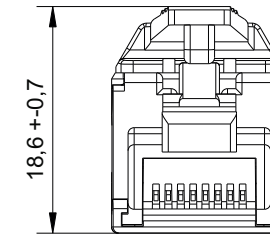
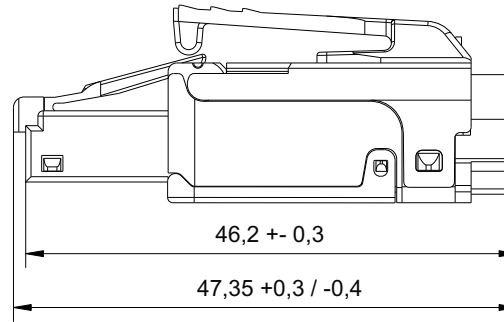
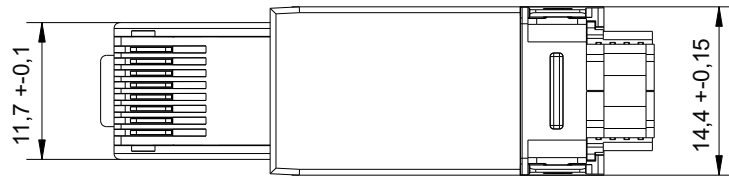

Bestellcodes:

- ohne Kabelabschluss CKSAO100
- inkl. Kabelabschluss AWG24-22 CKPK1001
- inkl. Kabelabschluss AWG27-26 CKPK6001

	gez. / drawn	18.06.2018	LP	 EasyLan® ...for a better connectivity
	gepr. / appr.	18.06.2018	MJ	
Titel / title:				Maße / Dimensions: mm
EasyLan® preLink® Steckermodul Kat.6A				
Zeichnungsnummer / drawing number:				Original: DIN A4
a	Neuerstellung	18.06.18	LP	Blatt / sheet 1 von / of 1
Änd./ rev. Index	Änderung/ revision code	Datum/ date	Name/ name	
ZN-CU181398				